

Article number: 586PL66

Description: Mini Push-in PL66, angle, M6 hose Ø6

Measures

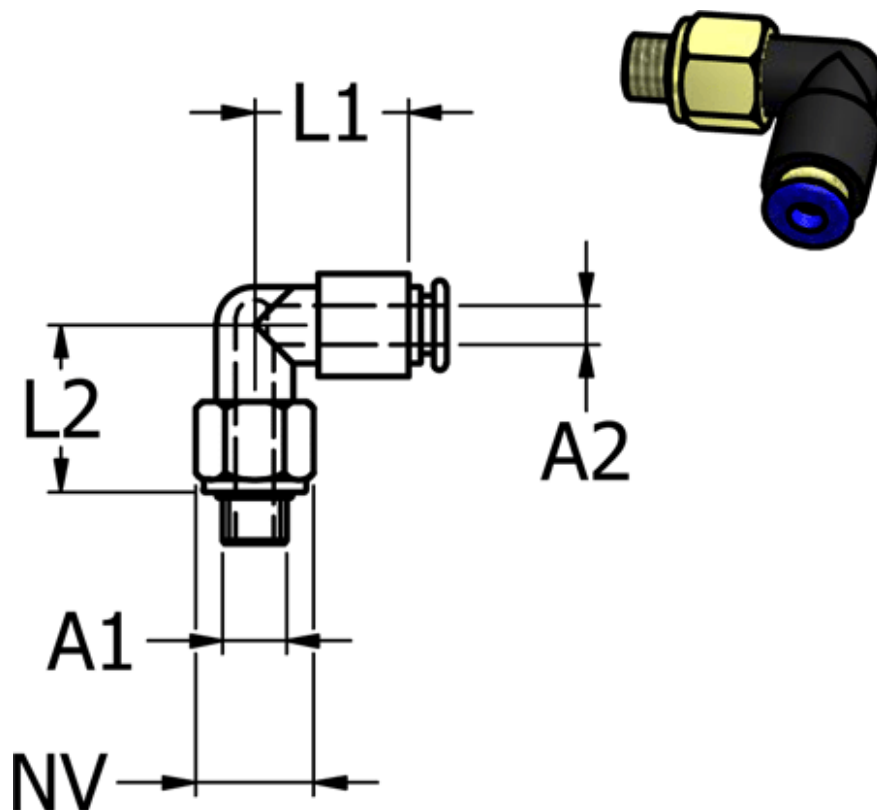

Ext. hose diameter A2 = 6 mm

L1 = 16

L2 = 17.6

NV = 10

Thread A! = M6